

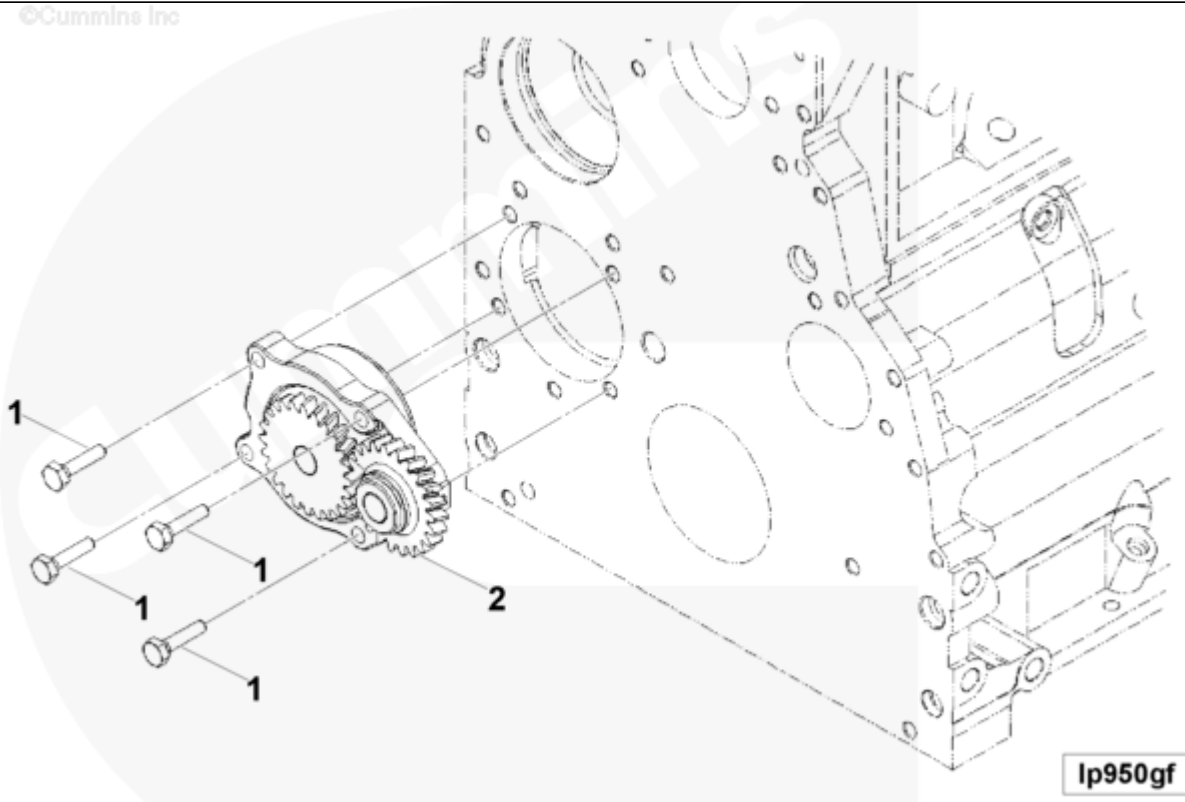

Parts Catalog - Option Detail

Electronic Parts Catalog - Option Detail				
Option	Group	Graphic	Film Card	Date
LP9714-02	07.06	lp950gf	T	18-JUL-00
Engines	4B3.9, 6A3.4, 6B5.9, B GAS INTERNATIONAL CM556, B4.5, B4.5 CM2350 B129B, B4.5 CM2350 B146C, B4.5 CM2350 B147B, B4.5 RGT, B4.5S, B5.9 G, B5.9 GAS PLUS CM556, B5.9 LPG, B5.9 LPG PLUS CM556, B6.7 CM2350 B121B, B6.7 CM2350 B135B, B6.7 CM2350 B136C, B6.7 CM2350 B148B, B6.7 G CMOH6.0 B125, B6.7N CM2380 B150B, B6.7S, F3.8 CM2350 F120B, F3.8 CM2350 F128C, F3.8 CM2350 F132B, F3.8 F102, G3.9, G5.9, G5.9 CM558, ISB (CHRYSLER), ISB CM2150, ISB CM2150 E, ISB CM550, ISB CM850, ISB/ISD4.5 CM2150 B119, ISB/ISD4.5 CM2150 SN, ISB/ISD6.7 CM2150 B120, ISB/ISD6.7 CM2150 SN, ISB/ISD6.7 CM2880 B126, ISB3.9 CM2220 B107, ISB4.5 CM2150, ISB5.9G CM2180, ISB6.7 2010 DCX PICKUP, ISB6.7 2013 DCX CHASSIS CAB, ISB6.7 CM2150 SQ, ISB6.7 CM2250, ISB6.7 CM2350 B101, ISB6.7 CM2350 B103, ISB6.7 CM2350 B142, ISB6.7 CM2670 B153B, ISB6.7 G CM2180 B118, ISBE CM2150, ISBE CM800, ISBE2/ISBE3 CM850, ISBE4 CM850, ISD4.5 CM2150, ISD6.7 CM2880 D101, ISF2.8 CM2220, ISF2.8 CM2220 AN, ISF2.8 CM2220 EC, ISF2.8 CM2220 ECF2, ISF2.8 CM2220 F101, ISF2.8 CM2220 F117, ISF2.8 CM2220 F122, ISF2.8 CM2220 F126, ISF2.8 CM2220 F129, ISF2.8 CM2220 IAN, ISF3.8 CM2220, ISF3.8 CM2220 AN, ISF3.8 CM2220 F103, ISF3.8 CM2220 F110, ISF3.8 CM2220 F116, ISF3.8 CM2220 F134B, ISF3.8 CM2220 IAN, ISF3.8 CM2350 F109, ISF4.5 CM2220 F123, ISG11 CM2880 G106, ISG11 CM2880 G108, ISG12 CM2880 G107, ISG12 CM2880 G109, ISG12 G CMOH6.0 G111, QSB3.9 30 CM550, QSB3.9 CM2880 B138, QSB4.5 30 CM550, QSB4.5 CM2150 B108, QSB4.5 CM2250 B131, QSB4.5 CM2250 EC, QSB4.5 CM2350 B106, QSB4.5 CM2350 B122			



SMALL | MEDIUM | LARGE

Cart	Ref No	Part Number	Part Description	Required	Remarks
View My Cart					
		LP9714-02	Lubricating Oil Pump		Lubricating Oil Pump...(More)

					Design Phase: Current Product
					Pump Drive: Non-Crank
					Concentric
					Body Material: Cast Iron
					Body
					Flow Rate (GPM @ RPM): 20.5
					@ 4200
					Gear Type: Steel HCR Gear
					Piston Cooling Method:
					Saddle Jet
					Engine Families: B Series
					Cylinders - Engine
					Aspiration:
					6 - Charge Air Cooled
					6 - Jacket Water Aftercooled
					6 - Naturally Aspirated
					6 - Sea Water Aftercooled
					6 - Turbocharged
<input type="checkbox"/>	1	3900677	Hexagon Head Cap Screw	4	M8 X 1.25 X 30.
<input type="checkbox"/>	2	3937404	Lubricating Oil Pump	1	Recon Equivalent 3937404 RX